

SNAPIN-OS

JOB# _____

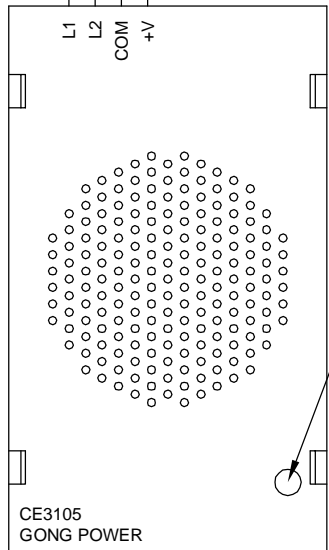
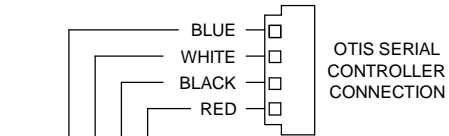

GONG VOLUME ACCESS
Use a small-bit straight-blade screwdriver and turn clockwise to increase the volume.

CE3105
GONG POWER

7-WIRE CABLE

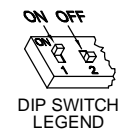
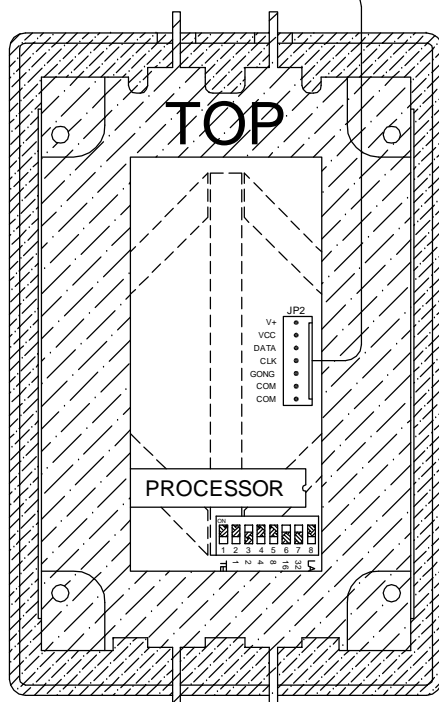

DEFAULT SETTINGS

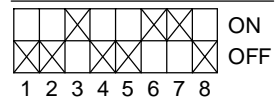

DIP SWITCH DETAIL

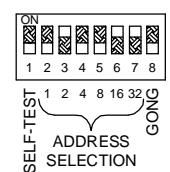
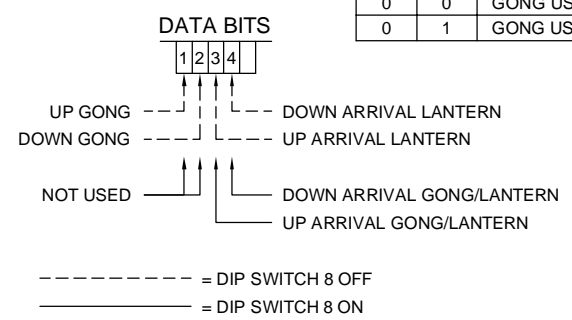

CHART TO SELECT ADDRESS WITH DIP SWITCH

DIP SWITCH #	VALUE						ADDRESS
	32	16	8	4	2	1	
0	0	0	0	0	0	0	INVALID
0	0	0	0	0	0	1	ADDRESS #32
0	0	0	0	0	1	0	ADDRESS #33
0	0	0	0	0	1	1	ADDRESS #34
0	0	0	0	1	0	0	ADDRESS #35
0	0	0	0	1	0	1	ADDRESS #36
0	0	0	0	1	1	0	ADDRESS #37
0	0	0	0	1	1	1	ADDRESS #38
0	0	0	1	0	0	0	ADDRESS #39
0	0	0	1	0	0	1	ADDRESS #40
0	0	0	1	0	1	0	ADDRESS #41
0	0	0	1	0	1	1	ADDRESS #42
0	0	0	1	1	0	0	ADDRESS #43
0	0	0	1	1	0	1	ADDRESS #44
0	0	0	1	1	1	0	ADDRESS #45
0	0	0	1	1	1	1	ADDRESS #46
0	0	1	0	0	0	0	ADDRESS #47
0	0	1	0	0	0	1	ADDRESS #48
0	0	1	0	0	1	0	ADDRESS #49
0	0	1	0	0	1	1	ADDRESS #50
0	0	1	0	1	0	0	ADDRESS #51
0	0	1	0	1	0	1	ADDRESS #52
0	0	1	0	1	1	0	ADDRESS #53
0	0	1	0	1	1	1	ADDRESS #54
0	0	1	1	0	0	0	ADDRESS #55
0	0	1	1	0	0	1	ADDRESS #56
0	0	1	1	0	1	0	ADDRESS #57
0	0	1	1	0	1	1	ADDRESS #58
0	0	1	1	1	0	0	ADDRESS #59
0	0	1	1	1	0	1	ADDRESS #60
0	0	1	1	1	1	0	ADDRESS #61
0	0	1	1	1	1	1	ADDRESS #62
0	1	0	0	0	0	0	ADDRESS #63
0	1	0	0	0	0	1	ADDRESS #32
0	1	0	0	0	1	0	ADDRESS #33
0	1	0	0	0	1	1	ADDRESS #34
0	1	0	0	1	0	0	ADDRESS #35
0	1	0	0	1	0	1	ADDRESS #36
0	1	0	0	1	1	0	ADDRESS #37
0	1	0	0	1	1	1	ADDRESS #38
0	1	0	1	0	0	0	ADDRESS #39
0	1	0	1	0	0	1	ADDRESS #40
0	1	0	1	0	1	0	ADDRESS #41
0	1	0	1	0	1	1	ADDRESS #42
0	1	0	1	1	0	0	ADDRESS #43
0	1	0	1	1	0	1	ADDRESS #44
0	1	0	1	1	1	0	ADDRESS #45
0	1	0	1	1	1	1	ADDRESS #46
0	1	1	0	0	0	0	ADDRESS #47
0	1	1	0	0	0	1	ADDRESS #48
0	1	1	0	0	1	0	ADDRESS #49
0	1	1	0	0	1	1	ADDRESS #50
0	1	1	0	1	0	0	ADDRESS #51
0	1	1	0	1	0	1	ADDRESS #52
0	1	1	0	1	1	0	ADDRESS #53
0	1	1	0	1	1	1	ADDRESS #54
0	1	1	1	0	0	0	ADDRESS #55
0	1	1	1	0	0	1	ADDRESS #56
0	1	1	1	0	1	0	ADDRESS #57
0	1	1	1	0	1	1	ADDRESS #58
0	1	1	1	1	0	0	ADDRESS #59
0	1	1	1	1	0	1	ADDRESS #60
0	1	1	1	1	1	0	ADDRESS #61
0	1	1	1	1	1	1	ADDRESS #62
0	1	1	1	1	1	1	ADDRESS #63

DIP1	DIP8	FUNCTION
1	X	SELF-TEST MODE
0	0	GONG USES BIT 1 UP (SINGLE) AND BIT 2 DOWN (DOUBLE)
0	1	GONG USES BIT 3 UP AND BIT 4 DOWN (BOTH SINGLE)



CODE VERSION _____

BOARD VERSION CE2575 _____

DATE DRAWN: 04/01/02	DRAWN BY: K.L.S.	REQUESTED BY: M.W., J.K.	
BOARD NUMBER: 2575, 3105	LAST DATE REVISED: 05/06/05	APPROVED BY:	
PRODUCT: SNAPIN-X	ENG. NO.: CE2575-01-A	REV: C	

The following Otis data must be furnished at the specified addresses for the Otis Serial Lantern to work properly. The address is selected by setting DIP switches 2-7 as shown on the back of this page. The board reads the address determined by the DIP switch setting. For example, if the DIP switch is set to address 50, the board will read the bits at address 50.

At DIP switch address—selected by the DIP switch setting on the unit (Default 50):

DIP switch 1 puts the unit in self-test mode.

DIP switch 1 and DIP switch 8 *OFF*:

- Bit 1—Up Gong (Single)
- Bit 2—Down Gong (Double)
- Bit 3—Up Arrival Arrow/Lantern
- Bit 4—Down Arrival Arrow/Lantern

DIP switch 1 *OFF* and DIP switch 8 *ON*:

- Bit 1—Not Used
- Bit 2—Not Used
- Bit 3—Up Arrival Arrow/Lantern and Up Gong (Single)
- Bit 4—Down Arrival Arrow/Lantern and Down Gong (Single)

NOTE: ECA function is not available with this unit.