

SMCDU

JOB# _____

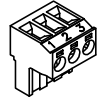

TYPICAL MICRO COMM CONNECTOR
1=COM 2=V+ 3=DATA

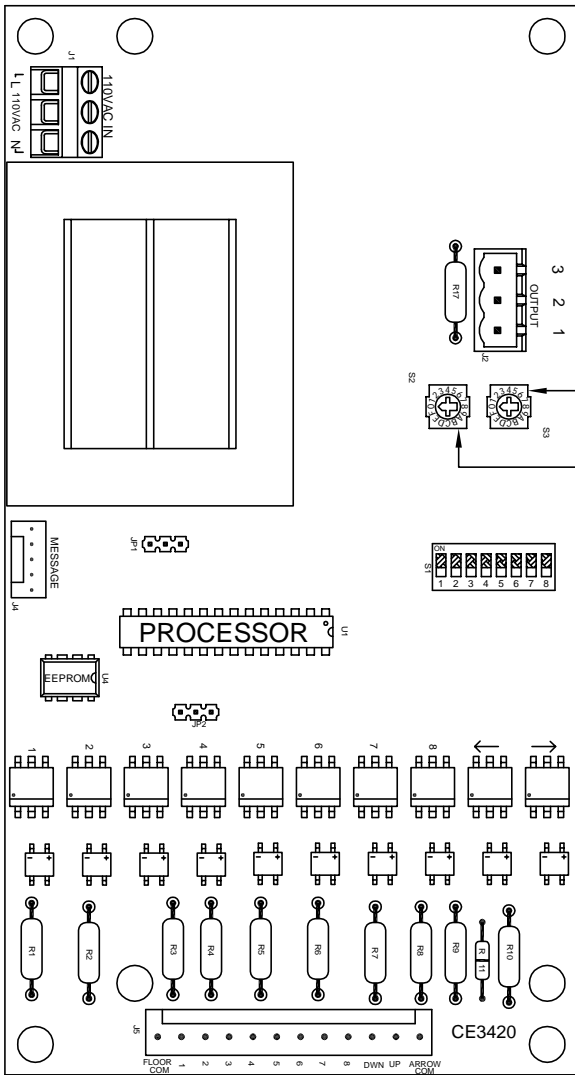
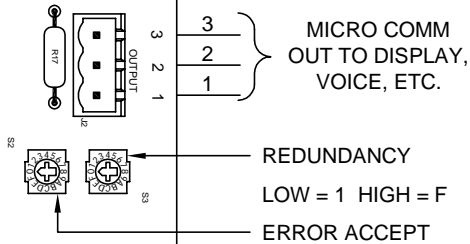

DIP SWITCH DETAIL



- 1 SELF-TEST
- 2 FAST TEST
- 3 PLAY STROBE INVERT / INPUT TEST
- 4 MESSAGE / ARRIVAL COMBO
- 5 MESSAGE PORT SLPF / BINARY
- 6 ZERO SCAN SLOT
- 7 NOT USED
- 8 INVERT MSG MODULE DATA

SIGNAL VOLTAGE (FROM CONTROLLER)

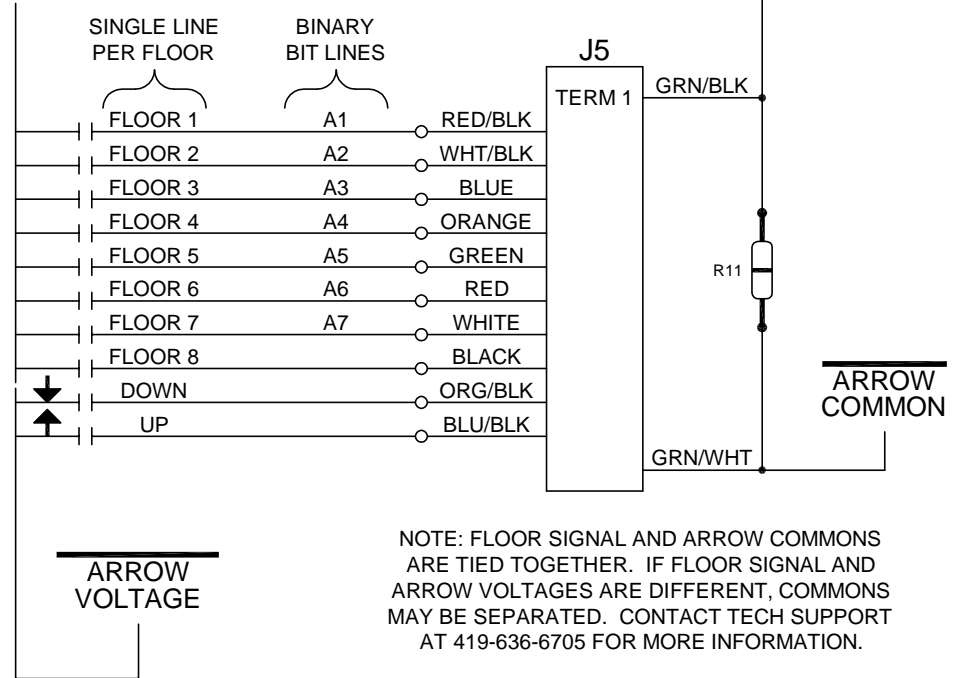

NOTE: FLOOR SIGNAL AND ARROW COMMONS ARE TIED TOGETHER. IF FLOOR SIGNAL AND ARROW VOLTAGES ARE DIFFERENT, COMMONS MAY BE SEPARATED. CONTACT TECH SUPPORT AT 419-636-6705 FOR MORE INFORMATION.

ARROW VOLTAGE

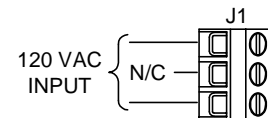
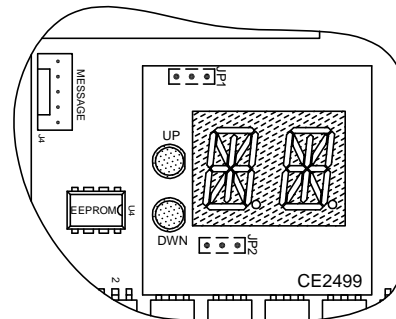

ROTARY SWITCH S2 _____

ROTARY SWITCH S3 _____

CODE VERSION _____

BOARD VERSION CE3420 _____

DEFAULT SETTINGS

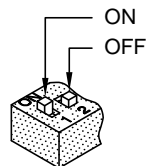
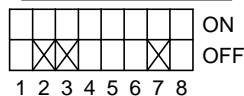

*NOTE: JP1 AND JP2 ARE FOR OPTIONAL DISPLAY MODULE - MDISP.

BINARY CHART ON BACK

DATE DRAWN: 01/21/08	DRAWN BY: DAC	REQUESTED BY: JK	 C.E. ELECTRONICS, INC. 2107 Industrial Drive Bryan, Ohio 43306 (419) 636-6705
BOARD NUMBER: 3420	LAST DATE REVISED: -	APPROVED BY: -	
PRODUCT SMCDU MICRO COMM DRIVER			DWG. NO. SMCDU014

BINARY FLOOR CHART

BINARY BITS

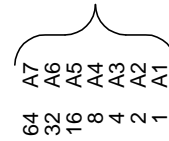

1000000 _____			
0111111 _____	0101111 _____	0011111 _____	0001111 _____
0111110 _____	0101110 _____	0011110 _____	0001110 _____
0111101 _____	0101101 _____	0011101 _____	0001101 _____
0111100 _____	0101100 _____	0011100 _____	0001100 _____
0111011 _____	0101011 _____	0011011 _____	0001011 _____
0111010 _____	0101010 _____	0011010 _____	0001010 _____
0111001 _____	0101001 _____	0011001 _____	0001001 _____
0111000 _____	0101000 _____	0011000 _____	0001000 _____
0110111 _____	0100111 _____	0010111 _____	0000111 _____
0110110 _____	0100110 _____	0010110 _____	0000110 _____
0110101 _____	0100101 _____	0010101 _____	0000101 _____
0110100 _____	0100100 _____	0010100 _____	0000100 _____
0110011 _____	0100011 _____	0010011 _____	0000011 _____
0110010 _____	0100010 _____	0010010 _____	0000010 _____
0110001 _____	0100001 _____	0010001 _____	0000001 _____
0110000 _____	0100000 _____	0010000 _____	0000000 _____

INSTALLATION GUIDE

1. Supply 110VAC power to the outer terminals of connector J1. The center terminal is not connected.
2. Turn on DIP switch one to start self-test. The unit will cycle through the floor/message data. Verify the floor markings displayed are the ones required for the job.
3. Verify the input resistors are fully seated in their sockets.
4. Connect the unit to the controller through the 12-pin MTA connector. The voltage, polarity, and input connections are marked on the reverse side of this diagram. This unit works like a light bulb. It must have voltage from common to the selected input.
5. For Single Line per Floor connections, there should only be one floor input wire with voltage present (with reference to common) at any time.
6. If the unit fails to operate properly, write down the serial number from the white job label on the unit and exactly what is displayed for each floor input . Contact Customer Tech Support at 419-636-6705.

DATE DRAWN: 06/23/05	DRAWN BY: DAC	REQUESTED BY: DAC	 <small>C.E. ELECTRONICS, INC. 2107 Industrial Drive Bryan, Ohio 43506 (419) 636-6705</small>
BOARD NUMBER: N/A	LAST DATE REVISED: -	APPROVED BY:	
PRODUCT SMCDU BINARY FLOOR CHART			
DWG. NO. SMCDU008			REV: -