

# OMN70

JOB# \_\_\_\_\_

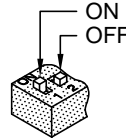
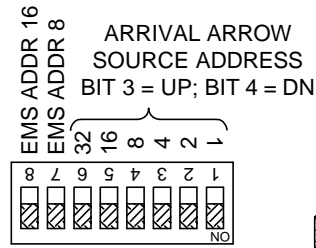
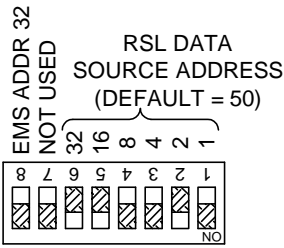
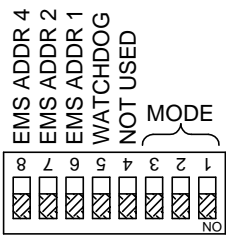

CE3547 \_\_\_ ARM CODE VERSION \_\_\_\_\_

CE3249 \_\_\_ MINI CODE VERSION \_\_\_\_\_

DESIGN VERSION \_\_\_\_\_

AUDIO VERSION \_\_\_\_\_

CRCG \_\_\_\_\_ OCDL CRC \_\_\_\_\_

CRCA \_\_\_\_\_ ODAA CRC \_\_\_\_\_

### S1 DEFAULT SETTINGS

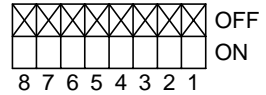

### S2 DEFAULT SETTINGS

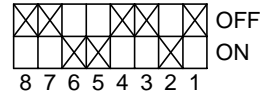

### S3 DEFAULT SETTINGS

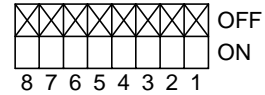

EMS ADDRESS						
EXAMPLE: EMS ADDR 37	ON (32)	OFF (0)	OFF(0)	ON (4)	OFF (0)	ON (1)
SWITCH (BIT VALUE)	S2-8 (32)	S3-8 (16)	S3-7 (8)	S1-8 (4)	S1-7 (2)	S1-6 (1)

32+4+1=37

MESSAGE MODULE PORT

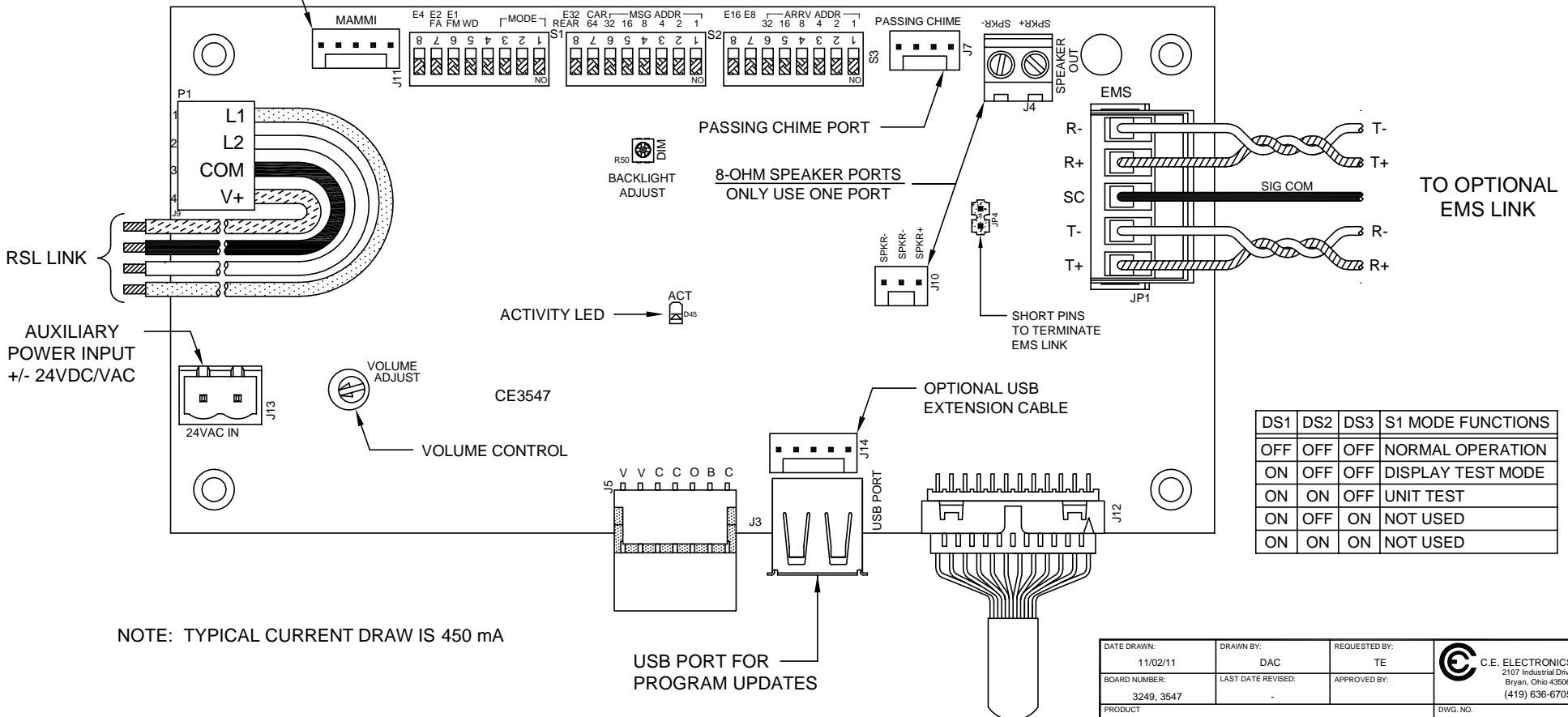

TO OPTIONAL  
EMS LINK

DS1	DS2	DS3	S1 MODE FUNCTIONS
OFF	OFF	OFF	NORMAL OPERATION
ON	OFF	OFF	DISPLAY TEST MODE
ON	ON	OFF	UNIT TEST
ON	OFF	ON	NOT USED
ON	ON	ON	NOT USED

NOTE: TYPICAL CURRENT DRAW IS 450 mA

DATE DRAWN: 11/02/11	DRAWN BY: DAC	REQUESTED BY: TE	<p>C.E. ELECTRONICS, INC. 2107 Industrial Drive Bryan, Ohio 43306 (419) 636-6705</p>
BOARD NUMBER: 3249, 3547	LAST DATE REVISED: -	APPROVED BY:	
PRODUCT OMN70 MINI-TFT DISPLAY		DWG. NO. OMNTFT_01	

The serial link must contain the following Otis data at the specified addresses for the display to work properly. Select the RSL Data address by setting S2, DIP switches 1-6 using the binary number for the desired address. The board reads five continuous addresses beginning with the address determined by the DIP switch setting. For example, if the DIP switch is set to address 50 (default), the board reads the bits at addresses 50-54.

DIP switch address - selected by the S2 DIP switch on the unit (Default 50):

Bit 1 - FDO	Front Door Open	>>>>>	Either of these will activate the play voice strobe,
Bit 2 - RDO	Rear Door Open	>>>>>	but also control which lantern inputs are read.
Bit 3 - Not Used			
Bit 4 - LPT	Landing Passing Tone		Passing Chime

DIP switch address +1 (Default 51):

Bit 3 - CUML	Car Up Motion Lamp	Travel Up Arrow
Bit 4 - CDML	Car Down Motion Lamp	Travel Down Arrow

DIP switch address +2 (Default 52):

Bit 1 - SESL	Fire Hat Jewel in COP	<u>Priority</u>
Bit 2 - FSL/RFSL	Fire Service Lamp	1
Bit 3 - FNDG/RNDG	Front/Rear Nudging	2
Bit 4 - ISCL	Independent Service Lamp	3
		4

DIP switch address +3 (Default 53):

Bit 1 - OLS	Overload Lamp	5
Bit 2 - Available	Message Six	6
Bit 3 - Available	Message Seven	7
Bit 4 - Available	Message Eight	8

DIP switch address +4 (Default 54):

Bit 3 and bit 4 contain Lantern UP and Lantern DOWN data when the arrival arrow address on S3 is set to zero.

NOTE: At DIP switch address +1 and +4, bits 1 and 2 are not used. Also, the messages listed at DIP switch address +2 and +3 are the default messages, but any signal can be used to trigger a message at the corresponding bit location.

Set the EMS Address (if used) using the following DIP switches in a binary format: S1-6 (1), S1-7 (2), S1-8 (4), S3-7 (8), S3-8 (16), and S2-8 (32).

Signal Name	GEN2 - E311M/E411M - GEM/MVS - E335M	LRVF - 211M/LVM
FDO	437	181
RDO	438	182
LPT	393	137
CUML	468	212
CDML	467	211
FSL	387	131
RFSL	416	160
FNDG	441	185
RNDG	442	186
FSILC	-	195
ISCL	389	133
OLS	396	140
PFL	397	141
EQL	383	127
CDLU	380	124
CDLD	378	122
RCDLU	401	145
RCDLD	399	143
CDLU2	754	259
CDLD2	755	258
RCDLU2	756	261
RCDLD2	757	260

NOTE: The CDLX2 signal is not HLSET dependent and is preferred for CE fixtures.

For destination-based systems, please contact C.E. Electronics Customer Service (419-636-6705) for more information.