

**MFLAG-XXXXXXX**  
LED EXTENDED DESTINATION ARROW



## DESTINATION-BASED

### LED EXTENDED DESTINATION ARROW

Long life, solid state LED's, 100,000 hour rated life. Accepts existing signals over the Micro Comm link. It includes arrival arrows which are green in the up direction and red in the down with Destination characters in blue for 180° viewing. Optional colors available.

This unit is also equipped with an arrival gong, and destination tones. The programming is dip switch selectable.

#### TYPICAL APPLICATIONS:

- > Hall/Destination Lanterns
- > Lantern/Destination combo w/ 180° viewing angle

#### FEATURES:

- > 2 1/2" & 3" characters
- > 180° viewing angle lantern
- > 1 year factory warranty
- > Conforms to ADAAG 4.10.4
- > Includes speaker

#### METAL:

- > 70100042
- > 70100046



**C.E. Electronics, Inc. (US)** 2107 Industrial Drive, Bryan, Ohio 43506 p: 419.636.6705 [www.cееlectronics.com](http://www.cееlectronics.com)

**C.E. Electronics, Ltd. (UK)** P.O. Box 1679 Marlow, Bucks SL7 3ZG, UK p: +44 (0) 1628 487633 [www.cееlectronics.co.uk](http://www.cееlectronics.co.uk)



Listed 5N50  
Elevator Accessory



C.E. Electronics, Inc.  
 2107 Industrial Drive  
 Bryan, OH 43506  
 PH (419) 636-6705 FX (419) 636-2516  
 www.ceelectronics.com

# MFLAG-XXXXXX

Ver. 9 Rel. 12/16/2020

DESTINATION  
 BASED

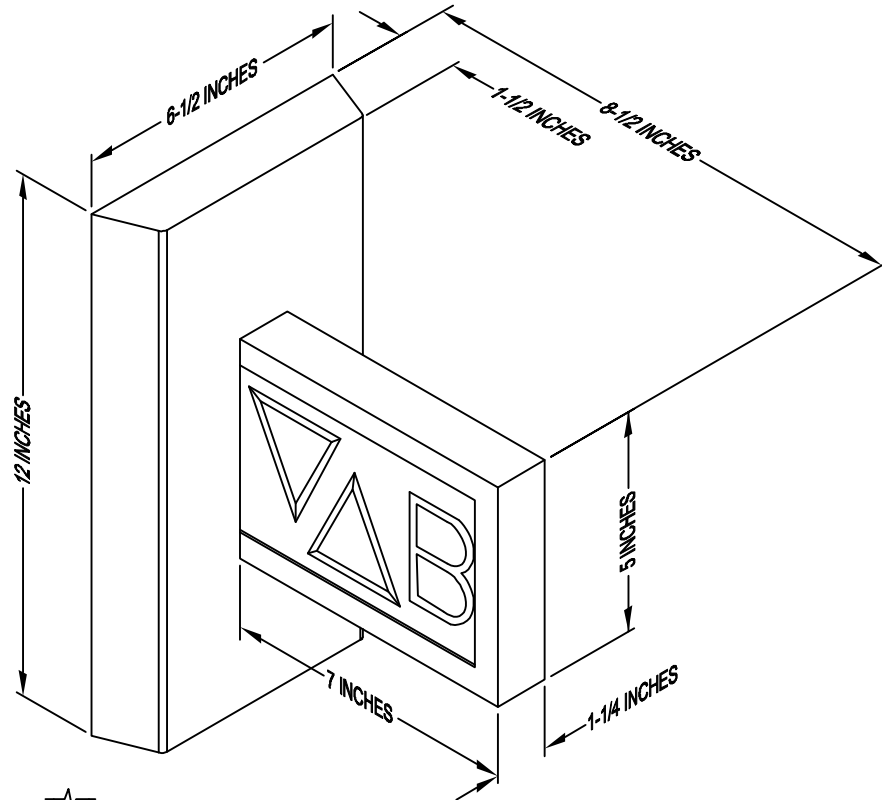

## MFLAG-XXXXXX

### LED EXTENDED DESTINATION ARROW

Long life, solid state LED's 100,000 hour rated life. Accepts existing signals over the MicroComm link. It includes arrival arrows which are green in the up direction and red in the down with Destination characters in blue for 180° viewing. Optional colors available. This unit is also equipped with an arrival gong, and destination tones. The programming is dip switch selectable.

### Typical Applications

- Hall/Destination Lanterns
- Lantern/Destination combo w/ 180° Viewing angle

### Features:

- 1-1/2 Inch - 3 Inch characters
- 180° viewing angle lantern
- 1 year factory warranty
- Conforms to ADAAG 4.10.4
- Includes speaker

TO ORDER: - SPECIFY MFLAG - XXXXXXX

### STYLE:

- "000" = CUSTOM
- "001" = INTERMEDIATE UP/DOWN ARROWS 3 INCH
- "002" = TERMINAL UP 3 INCH
- "003" = TERMINAL DOWN 3 INCH
- "004" = INTERMEDIATE UP/DOWN w/ CHARACTER(S)
- "005" = TERMINAL UP w/ SINGLE CHARACTER 3 INCH
- "006" = TERMINAL DOWN w/ SINGLE CHARACTER 3 INCH
- "007" = NO ARROW 3 INCH CHARACTER 1 OR 2 DIGITS
- "008" = BOARD ONLY REPLACEMENT
- "009" = BACK BOARD ONLY

### COLOR:

(Up color, Down color, Character color)  
 XXX = Combinations of Red, Green, Blue, White

### METAL:

- "1" = #4 Stainless Steel
- "2" = #8 Stainless Steel
- "3" = #4 Muntz 60/40
- "4" = #8 Muntz 60/40
- "C" = Custom

### Custom Options:

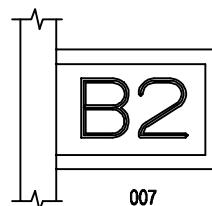
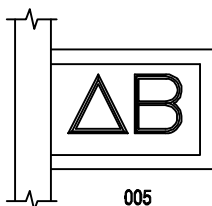
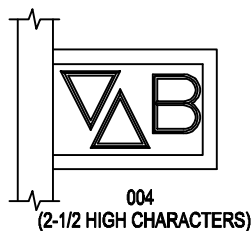
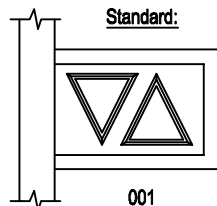
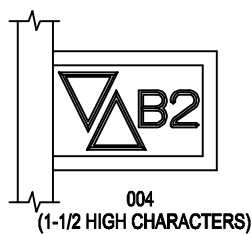

~ Some features may not be available for your system. Please check with your manufacture or engineering for special features. ~

NOTE: Lead times vary

**MFLAG STYLE VARIATIONS:**

Custom Option:

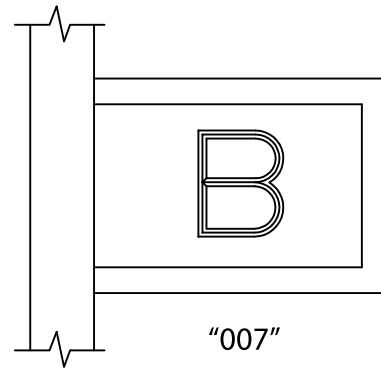
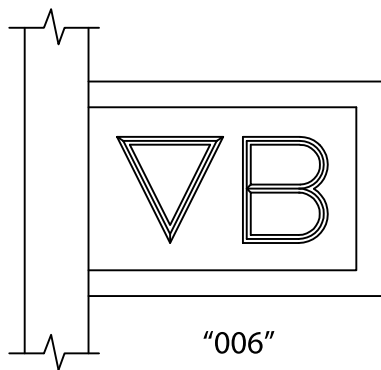
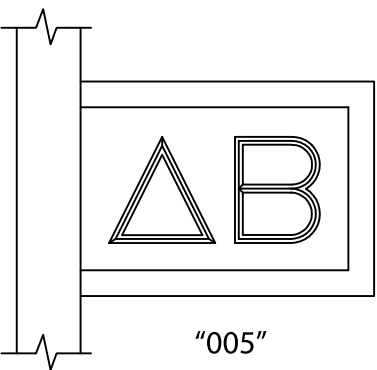
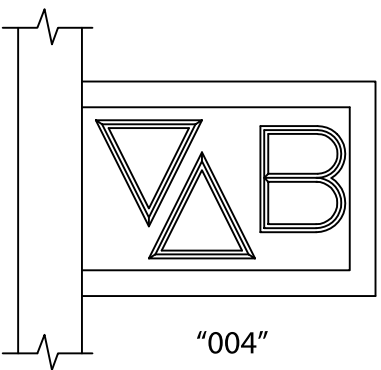
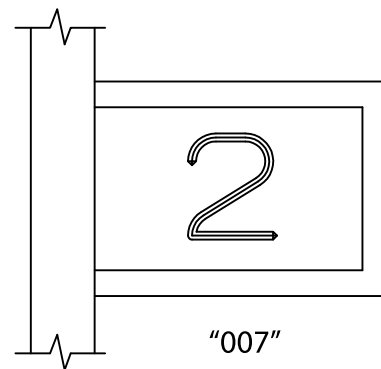
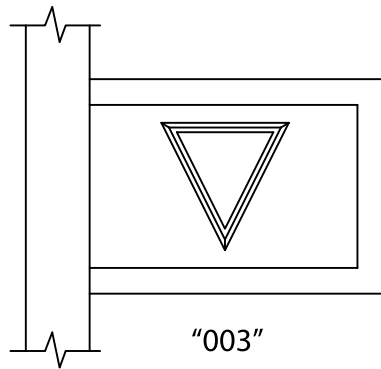
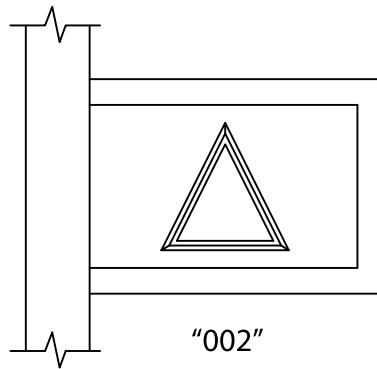
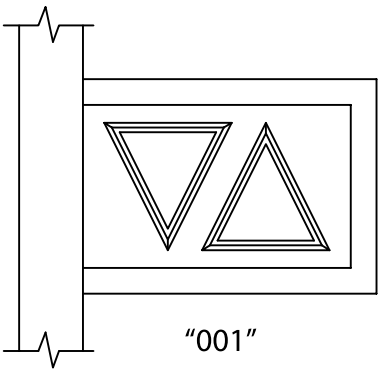
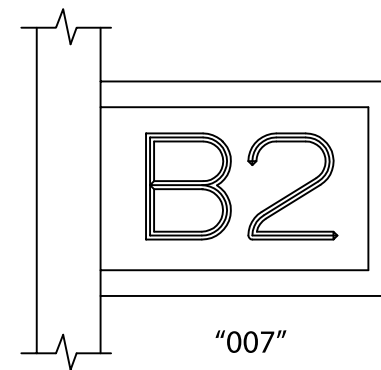
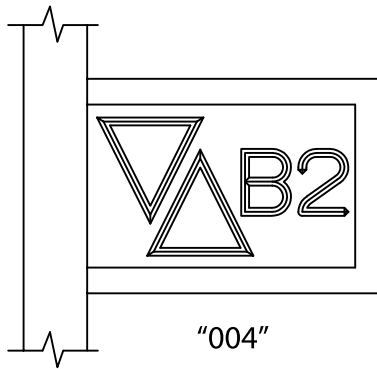
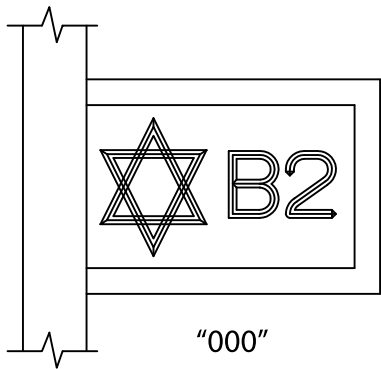

# MFLAG-X

JOB# \_\_\_\_\_

CHART TO SET FLOOR ADDRESS WITH DIP SWITCH

32 16 8 4 2 1 — BIT VALUE —						32 16 8 4 2 1							
DS6	DS5	DS4	DS3	DS2	DS1	FLOOR	DS6	DS5	DS4	DS3	DS2	DS1	FLOOR
OFF	OFF	OFF	OFF	OFF	OFF	ALL CALL	ON	OFF	OFF	OFF	OFF	OFF	FLOOR 32
OFF	OFF	OFF	OFF	OFF	ON	FLOOR 1	ON	OFF	OFF	OFF	OFF	ON	FLOOR 33
OFF	OFF	OFF	OFF	ON	OFF	FLOOR 2	ON	OFF	OFF	OFF	ON	OFF	FLOOR 34
OFF	OFF	OFF	OFF	ON	ON	FLOOR 3	ON	OFF	OFF	OFF	ON	ON	FLOOR 35
OFF	OFF	OFF	ON	OFF	OFF	FLOOR 4	ON	OFF	OFF	ON	OFF	OFF	FLOOR 36
OFF	OFF	OFF	ON	OFF	ON	FLOOR 5	ON	OFF	OFF	ON	OFF	ON	FLOOR 37
OFF	OFF	OFF	ON	ON	OFF	FLOOR 6	ON	OFF	OFF	ON	ON	OFF	FLOOR 38
OFF	OFF	OFF	ON	ON	ON	FLOOR 7	ON	OFF	OFF	ON	ON	ON	FLOOR 39
OFF	OFF	ON	OFF	OFF	OFF	FLOOR 8	ON	OFF	ON	OFF	OFF	OFF	FLOOR 40
OFF	OFF	ON	OFF	OFF	ON	FLOOR 9	ON	OFF	ON	OFF	OFF	ON	FLOOR 41
OFF	OFF	ON	OFF	ON	OFF	FLOOR 10	ON	OFF	ON	OFF	ON	OFF	FLOOR 42
OFF	OFF	ON	OFF	ON	ON	FLOOR 11	ON	OFF	ON	OFF	ON	ON	FLOOR 43
OFF	OFF	ON	ON	OFF	OFF	FLOOR 12	ON	OFF	ON	ON	OFF	OFF	FLOOR 44
OFF	OFF	ON	ON	OFF	ON	FLOOR 13	ON	OFF	ON	ON	OFF	ON	FLOOR 45
OFF	OFF	ON	ON	ON	OFF	FLOOR 14	ON	OFF	ON	ON	ON	OFF	FLOOR 46
OFF	OFF	ON	ON	ON	ON	FLOOR 15	ON	OFF	ON	ON	ON	ON	FLOOR 47
OFF	ON	OFF	OFF	OFF	OFF	FLOOR 16	ON	ON	OFF	OFF	OFF	OFF	FLOOR 48
OFF	ON	OFF	OFF	OFF	ON	FLOOR 17	ON	ON	OFF	OFF	OFF	ON	FLOOR 49
OFF	ON	OFF	OFF	ON	OFF	FLOOR 18	ON	ON	OFF	OFF	ON	OFF	FLOOR 50
OFF	ON	OFF	OFF	ON	ON	FLOOR 19	ON	ON	OFF	OFF	ON	ON	FLOOR 51
OFF	ON	OFF	ON	OFF	OFF	FLOOR 20	ON	ON	OFF	ON	OFF	OFF	FLOOR 52
OFF	ON	OFF	ON	OFF	ON	FLOOR 21	ON	ON	OFF	ON	OFF	ON	FLOOR 53
OFF	ON	OFF	ON	ON	OFF	FLOOR 22	ON	ON	OFF	ON	ON	OFF	FLOOR 54
OFF	ON	OFF	ON	ON	ON	FLOOR 23	ON	ON	OFF	ON	ON	ON	FLOOR 55
OFF	ON	ON	OFF	OFF	OFF	FLOOR 24	ON	ON	ON	OFF	OFF	OFF	FLOOR 56
OFF	ON	ON	OFF	OFF	ON	FLOOR 25	ON	ON	ON	OFF	OFF	ON	FLOOR 57
OFF	ON	ON	OFF	ON	OFF	FLOOR 26	ON	ON	ON	OFF	ON	OFF	FLOOR 58
OFF	ON	ON	OFF	ON	ON	FLOOR 27	ON	ON	ON	OFF	ON	ON	FLOOR 59
OFF	ON	ON	ON	OFF	OFF	FLOOR 28	ON	ON	ON	ON	OFF	OFF	FLOOR 60
OFF	ON	ON	ON	OFF	ON	FLOOR 29	ON	ON	ON	ON	OFF	ON	FLOOR 61
OFF	ON	ON	ON	ON	OFF	FLOOR 30	ON	ON	ON	ON	ON	OFF	FLOOR 62
OFF	ON	ON	ON	ON	ON	FLOOR 31	ON	ON	ON	ON	ON	ON	FLOOR 63

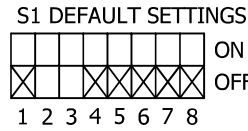
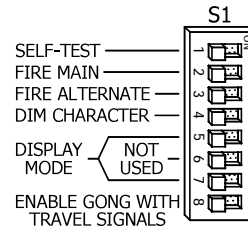

S1-5	S1-7	DISPLAY MODE
OFF	OFF	SHOW ARROWS
OFF	ON	SHOW CHARACTER
ON	OFF	SHOW BOTH
ON	ON	SHOW NEITHER

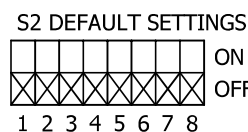
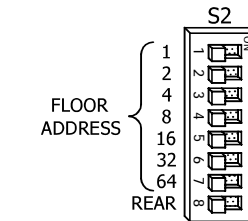

Use a MICRO COMM<sup>®</sup> source to send messages with the level required to activate the features listed below.

To blank the display during a fire main (level three) message, turn on DIP switch S1-2 (FM).

To blank the display during a fire alternate (level two) message, turn on DIP switch S1-3 (FA).

Use the chart above to set the DIP switches for the floor the unit is located on. Set up the MICRO COMM<sup>®</sup> source to send arrival information.

Turn off S2-1 through S2-7 to put the display in travel mode. The LEDs react to all travel direction changes. Turn on S1-8 to allow the gong to also use travel information.

Turn on S2-1 - S2-7 to put the unit in "ALL CALL" mode using in-car lantern signals. The LEDs and gong react to all arrival events, regardless of the floor the elevator is located at.

To set the unit for a floor above 63, turn on DIP switch S2-7 (64) and set DIP switches S2-1 to S2-6 as shown on the chart, subtracting 64 from the desired floor number. For example, to set the unit for floor 75, turn on DIP switch S2-7 and set DIP switches S2-1 to S2-6 for floor 11 (75 - 64 = 11).

To operate the display as a rear unit turn on DIP switch S2-8 (REAR). NOTE: The MICRO COMM<sup>®</sup> driver must send the MC2000 data stream to use this feature. Call Tech Support at 419-636-6705 for more information.

To use the gong option, set the S3 GONG/VOICE switch to GONG. To use the voice option, install the optional CE3557 voice board and set the S3 GONG/VOICE switch to VOICE.

NOTE: MUST BE USED WITH A CLASS 2 POWER SUPPLY.

CODE VERSION \_\_\_\_\_

BOARD VERSION CE3270 \_\_\_\_

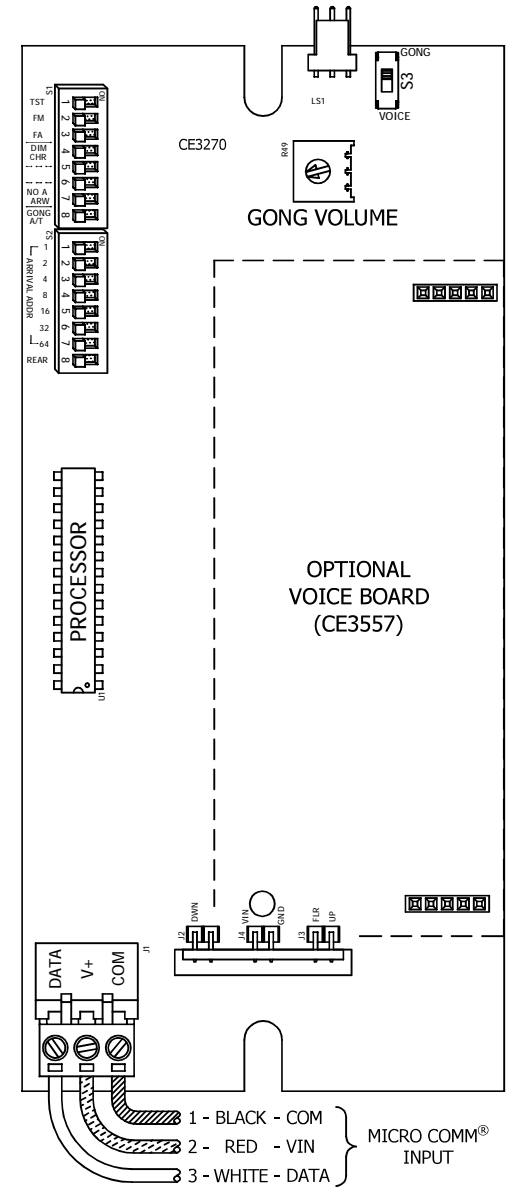

DATE DRAWN: 06/10/08	DRAWN BY: DAC	REQUESTED BY: JK	 C.E. ELECTRONICS, INC. 2107 Industrial Drive Bryan, OHIO 43306 (419) 636-6705
BOARD NUMBER: 3270	LAST DATE REVISED: 04/20/23	APPROVED BY:	
PRODUCT FLAG DISPLAY WITH MICRO COMM <sup>®</sup> INPUT			DWG. NO. MFLAG_01

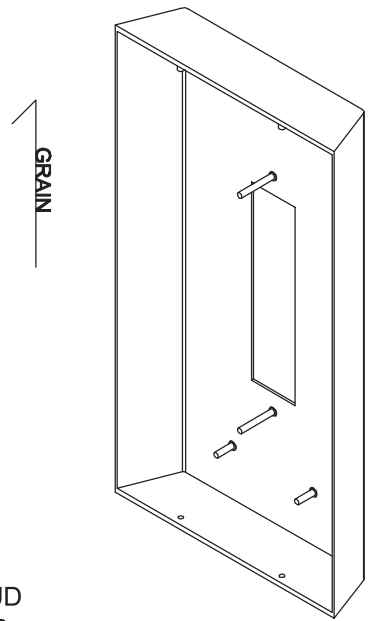
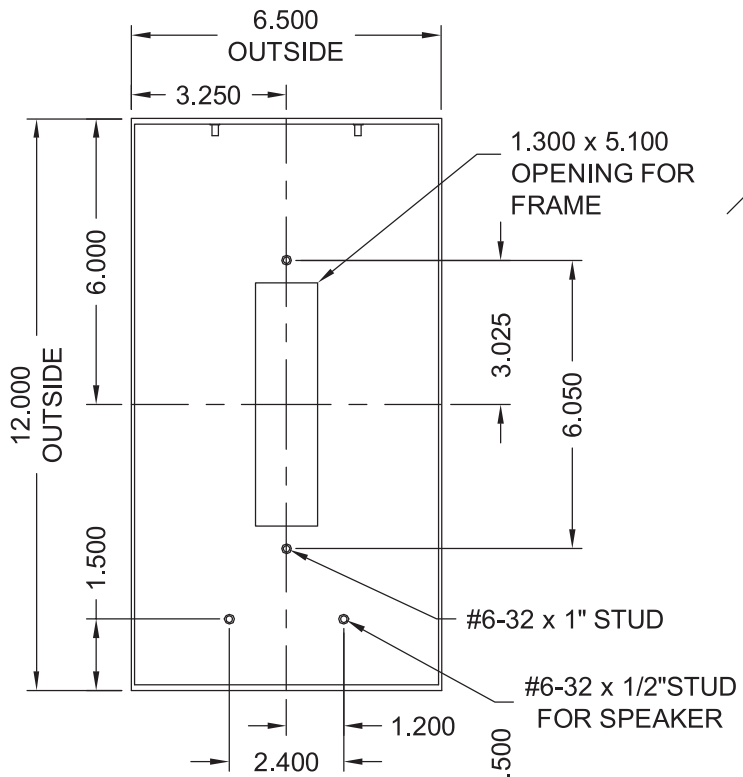

METAL: 70100046

NOTES:  
304 STAINLESS STEEL #4 FINISH

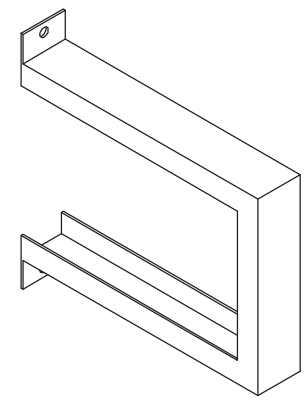
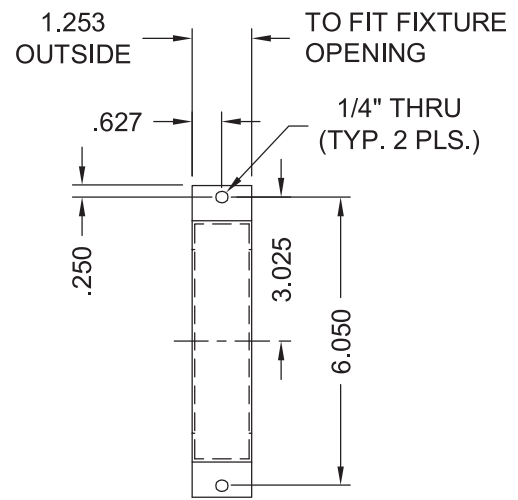
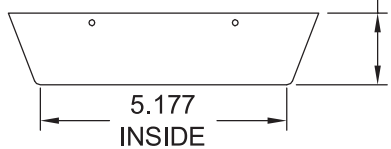

METAL: 70100042

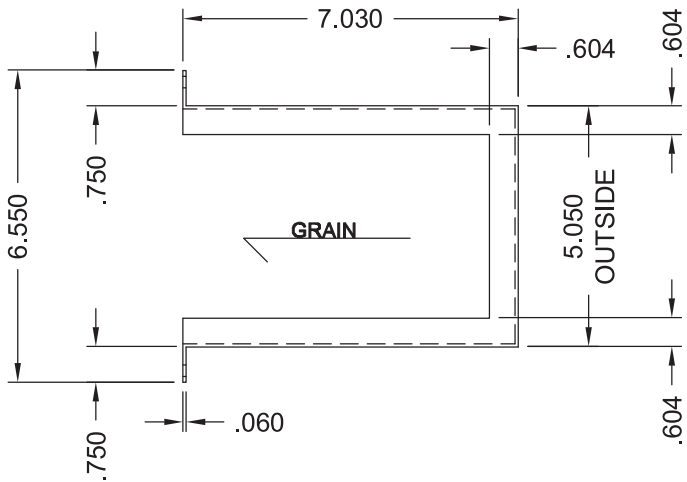

DATE DRAWN: 7/30/08		LAST DATE REVISED:		SCALE: NONE		PART #:	
DRAWN BY: D.W.S.		TOLERANCE UNLESS OTHERWISE SPECIFIED: +0.015,-0.015		 C.E. ELECTRONICS, INC. 2107 Industrial Drive Bryan, Ohio 43506 (419) 636-6705		APPROVED BY:	
REQUESTED BY: R.N.T.		TOLERANCE FOR CUTOUT (WINDOW): +0.020,-0.000				Signature: _____	
TITLE: C.E. FLAG FRAME		DWG. NO.: Q5609001-14		REV.:		Date: _____	
				Company: _____		BOARD # & REV.:	