

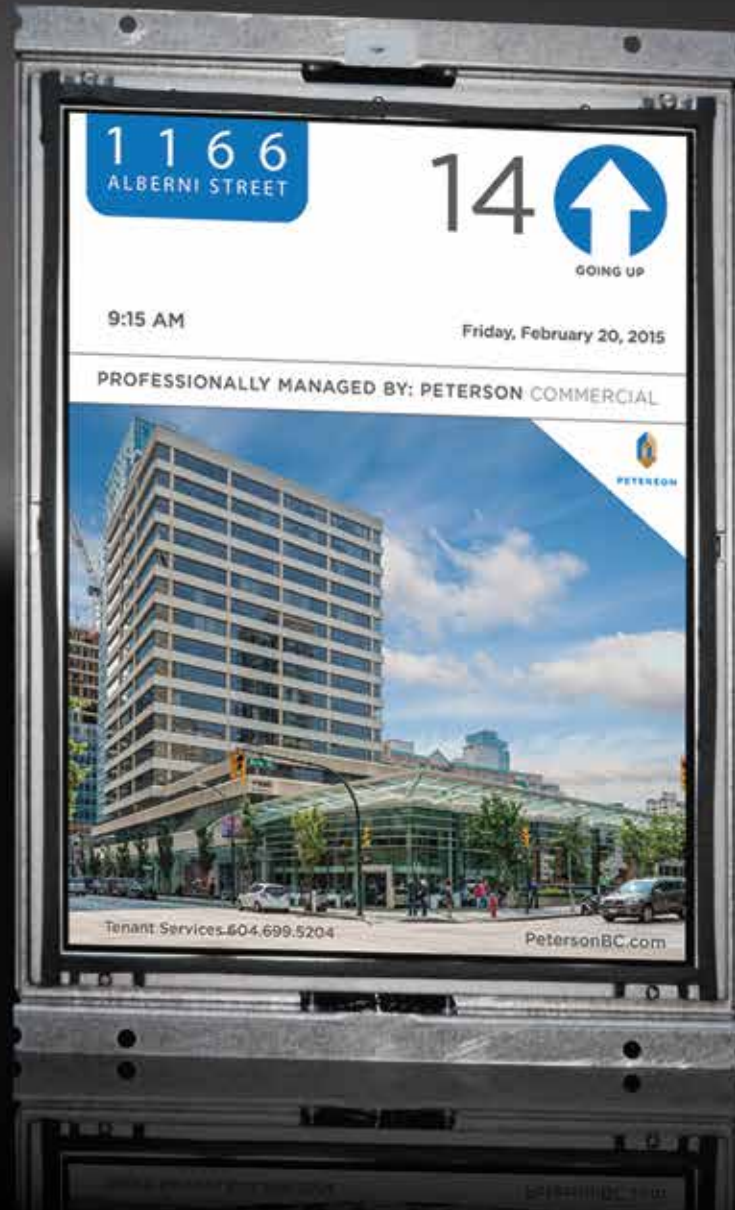

## EX150-PT2

15" ELITE PI PORTRAIT SERIES



## ELITE PI

15" Elite PI Portrait Series

The MICRO COMM Elite PI is the most flexible position indicator available. With the Elite PI Designer software, you can customize your own position indicator by selecting background colors and textures, fonts, and arrow styles. This system is so flexible you can even determine where the display elements appear on the screen. In addition to design flexibility, the MICRO COMM Elite PI can display floor, priority, and time-based messages.

### TYPICAL APPLICATIONS:

- > Car operating panel
- > Car transom
- > Lobby

### FEATURES:

- > Standard Elite streaming video capabilities with an HDINT video encoder
- > Passing chime output
- > Self testing
- > Low profile
- > Elite PI Designer software
- > Elite PI Transfer software
- > Multi-car capabilities for hallway use
- > MICRO COMM serial link input



**C.E. Electronics, Inc. (US)** 2107 Industrial Drive, Bryan, Ohio 43506 p: 419.636.6705 [www.ceelectronics.com](http://www.ceelectronics.com)

**C.E. Electronics, Ltd. (UK)** P.O. Box 1679 Marlow, Bucks SL7 3ZG, UK p: +44 (0) 1628 487633 [www.ceelectronics.co.uk](http://www.ceelectronics.co.uk)



# EX150-PT2

Ver. 1 Rel. 6/16/2022

ELITE PI®

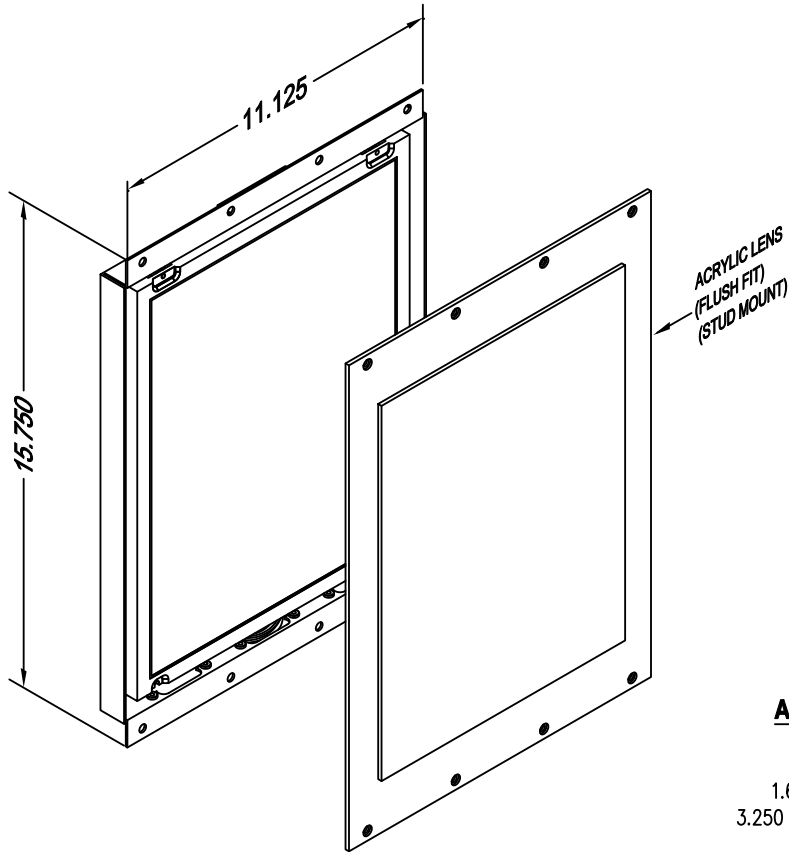

Main Screen is 3 Inches Deep  
 Auxiliary Screen is 2-1/4 Deep  
 3-1/2 Inch Box Depth Recommended

## AS VIEWED FROM FRONT

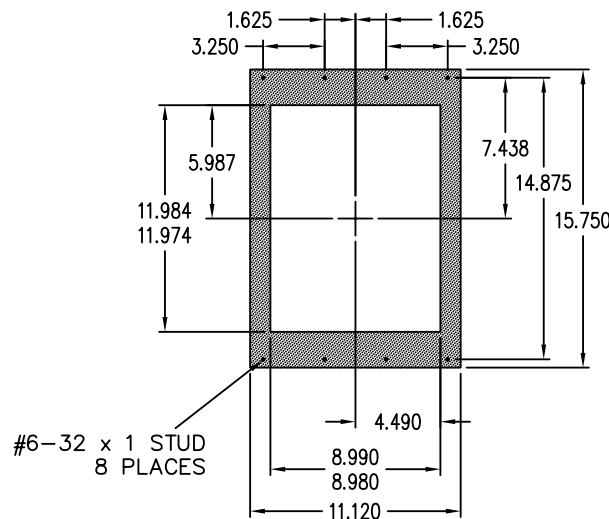

## 15 INCH Elite PI-Portrait

The Micro Comm Elite PI is the most flexible position indicator available. With the Elite PI Designer software, you can customize your own position indicator by selecting background colors and textures, fonts, and arrow styles. This system is so flexible you can even determine where the display elements appear on the screen. In addition to design flexibility, the Micro Comm Elite PI can display floor, priority, and time-based messages.

### Typical Applications

- Car operating panel
- Car transom
- Lobby

### Features:

- Standard Elite has streaming video capabilities with an HDINT video encoder
- Passing chime output
- Self testing
- Low profile
- Elite PI Designer software
- Elite PI Transfer software
- Multi-car capabilities for hallway use
- MICRO COMM serial link input

**TO ORDER: - EX150 - PT2**

"L" = STANDARD

"A" = AUXILIARY PANEL LINK

### RELATED DRAWINGS

DESCRIPTION	DRAWING NAME
PANEL PREP.	PP150-2
DETAIL DIM.	DD150-2

# DD150-2

Ver. 1 Rel. 07/10/09

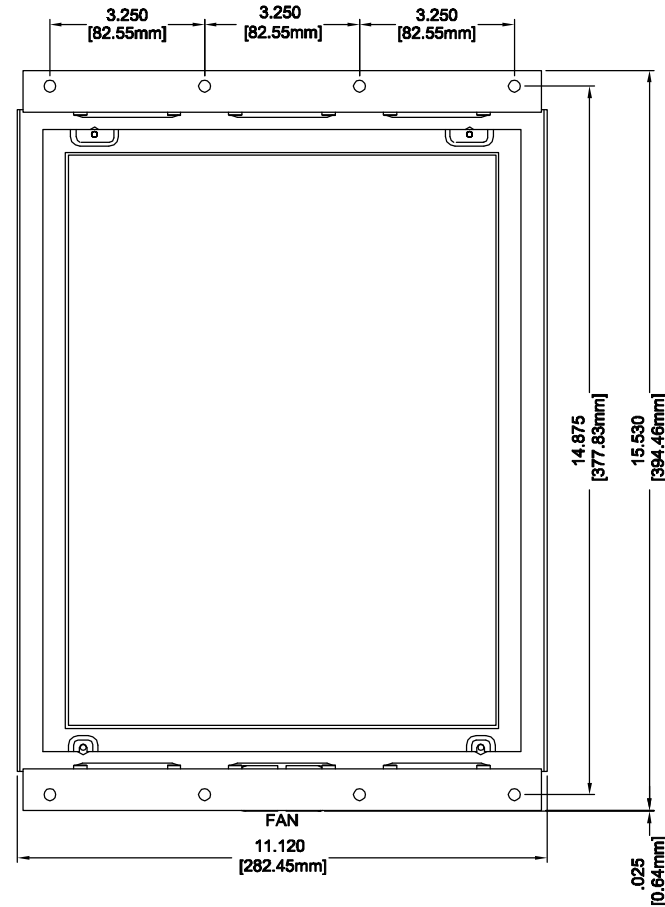
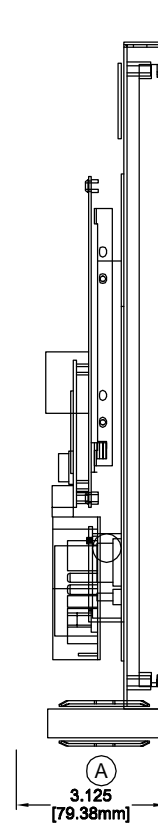
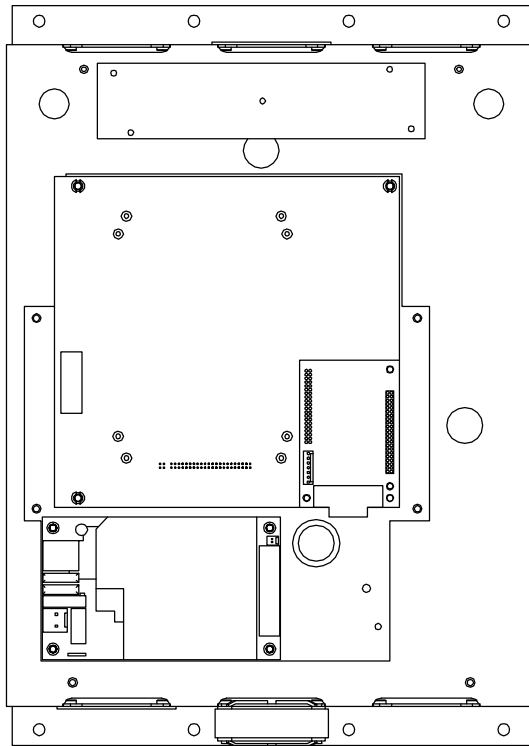

**NOTES:**

**STANDARD 15 TFT UNIT:**

- (A) Recommended minimum depth with basic unit of at least 3.25" [82.55mm] with a standard 1/8" step lens.

LENS NUMBER:	BOARD # & REV:
APPROVED BY:	
Signature: _____	
Date: _____	
Company: _____	

DATE DRAWN: 7/10/09	LAST DATE REVISED:	SCALE: NONE	PART #:
DRAWN BY: D.W.S.	TOLERANCE UNLESS OTHERWISE SPECIFIED: +0.015, -0.015		 C.E. ELECTRONICS, INC. 2107 Industrial Drive Bryan, Ohio 43506 (419) 636-6705
REQUESTED BY: T.E.	TOLERANCE FOR CUTOUT (WINDOW): +0.020, -0.000		
TITLE:			DWG. NO. DD150-2
			REV:

# PP150-2

Ver. 2 Rel. 1/09/2017

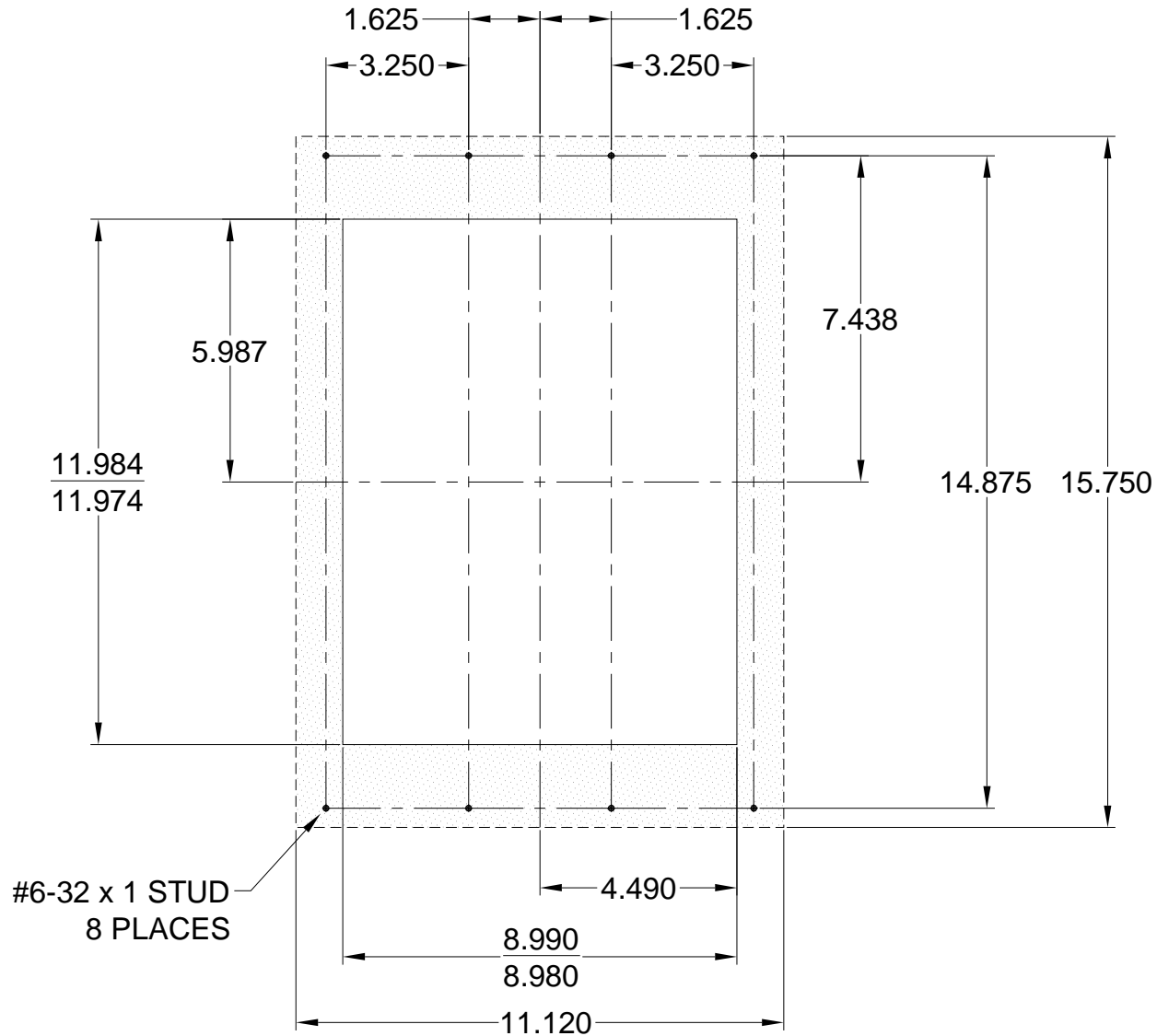

LENS NUMBER:	BOARD # & REV:
APPROVED BY:	
Signature: _____	
Date: _____	
Company: _____	

DATE DRAWN: 7/10/09	LAST DATE REVISED:	SCALE: NONE	PART #:
DRAWN BY: D.W.S.	TOLERANCE UNLESS OTHERWISE SPECIFIED: +0.015,-0.015		C.E. ELECTRONICS, INC. 2107 Industrial Drive Bryan, Ohio 43506 (419) 636-6705
REQUESTED BY: T.E.	TOLERANCE FOR CUTOUT (WINDOW): +0.020,-0.000		
TITLE: PORTRAIT 15" TFT PANEL PREP			DWG. NO. PP150-2
			REV:

# MAIN TFT

(BACK VIEW)

JOB# \_\_\_\_\_

## S1 DEFAULT SETTINGS

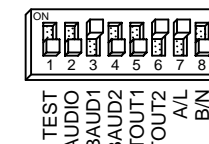
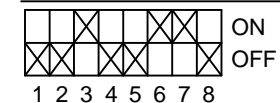

## S2 DEFAULT SETTINGS

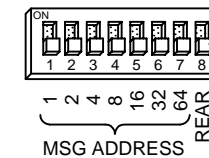
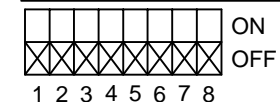

ROTARY SWITCH S3 \_\_\_\_\_

ROTARY SWITCH S4 \_\_\_\_\_

ARM CODE VERSION \_\_\_\_\_

DISPLAY CODE VER \_\_\_\_\_

OS VERSION \_\_\_\_\_

Q7 MODULE \_\_\_\_\_

BRACKET NO. \_\_\_\_\_

VIDEO STANDARD: NTSC   
PAL

IP: \_\_\_\_\_

MASK: \_\_\_\_\_

\* - ITEMS INSTALLED ON VIDEO VERSION ONLY

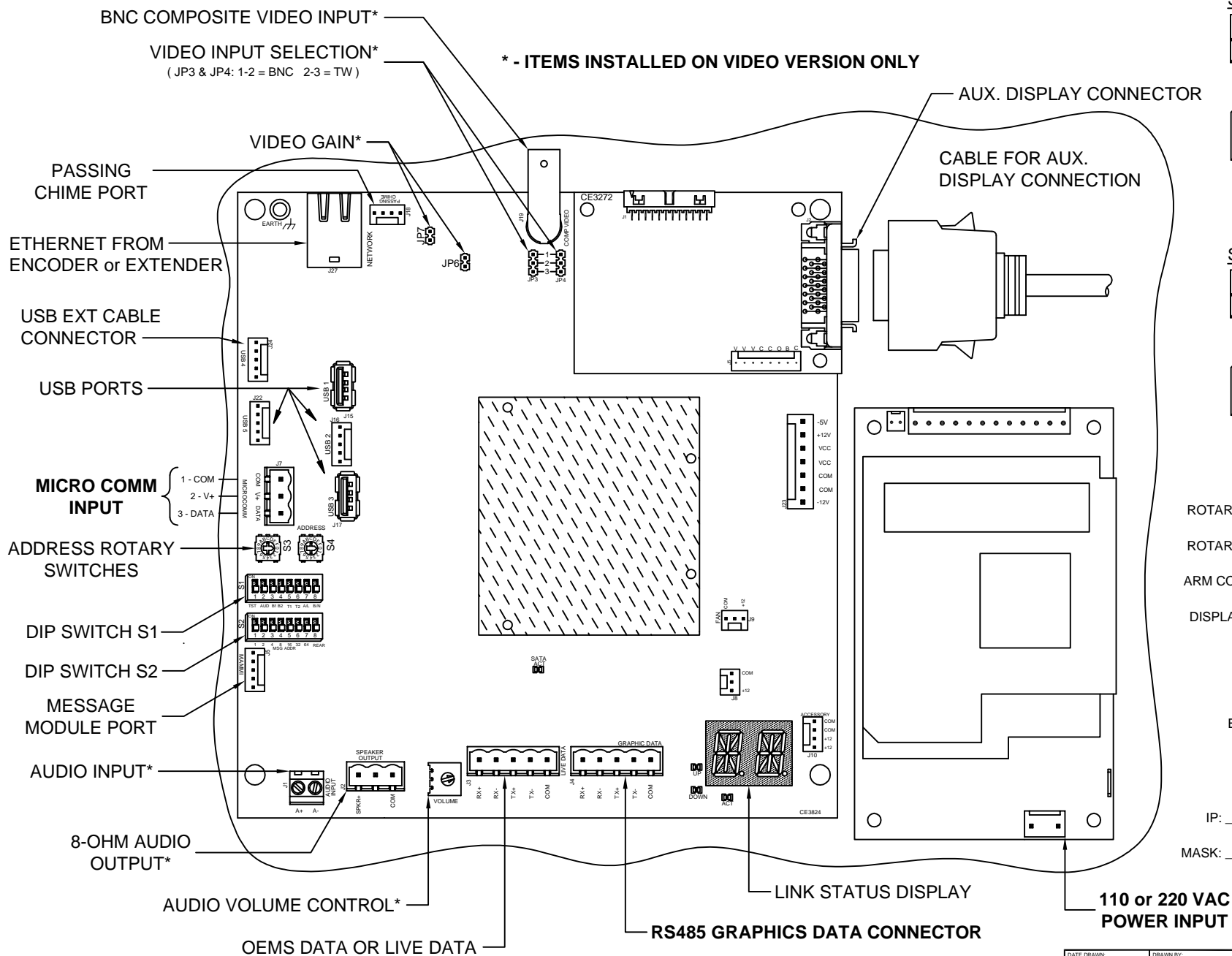

DATE DRAWN: 02/02/16	DRAWN BY: DAC	REQUESTED BY: TE	<p>C.E. ELECTRONICS, INC. 2107 Industrial Drive Bryan, Ohio 43006 (419) 636-6705</p>
BOARD NUMBER: 3824, 3272	LAST DATE REVISED: -	APPROVED BY:	
PRODUCT ELITE PI MAIN - LVDS			
DWG. NO. 104TFTBACK_3824			

## S1 DIP SWITCH SETTINGS

### DIP Switch 1 - Test Mode

Off = Normal Run Mode  
On = The display will cycle up and down through all programmed floors (Front Side Only).

### DIP Switch 2 - Audio Output

Off = Audio Software Controlled  
On = Audio Enabled

### DIP Switch 4, 3 - RS485 Configuration Link Baud Rate (Must match Transfer Program)

DS4	DS3	BAUD RATE
OFF	OFF	9600
OFF	ON	19200 (Default)
ON	OFF	38400
ON	ON	57600

### DIP Switch 6, 5 - Watchdog Period (Length of time the PIC waits for a response from Elite Display before resetting the display)

DS6	DS5	Wait Period
OFF	OFF	One Minute
OFF	ON	Two Minutes
ON	OFF	Three Minutes (Default)
ON	ON	Never Reset Display

### DIP Switch 7 - Converter Board Display Mode (does not affect TFT screen)

Off = Scan Slot Data Displayed  
On = ASCII Data Displayed

NOTE: Left Cube Dot = Priority Message Sent  
Right Cube Dot = Door Strobe Active

### DIP Switch 8 - Single/Multi-Car

Off = Single Car - Standard MICRO COMM Links  
On = Multi-Car - Special 8-to-1 MICRO COMM Links Only!

## ROTARY SWITCH SETTINGS

Rotary Switch S3 - Used for USB transfers. Default setting is 0.

Rotary Switch S4 - Unit Address

This switch sets the address of the Elite PI unit. The default is address 1, which is switch setting 0.

NOTE: This address must match the Transfer program setting.

S4	Unit Address	S4	Unit Address	S4	Unit Address	S4	Unit Address
0	1	4	5	8	9	C	13
1	2	5	6	9	10	D	14
2	3	6	7	A	11	E	15
3	4	7	8	B	12	F	16

### MICRO COMM LINK (18-GAUGE WIRE)

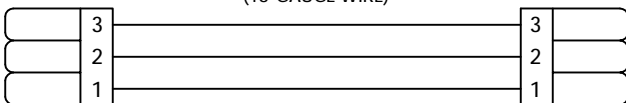

### SMARTMUX to ELITE PI and (if needed) to ELITE PI

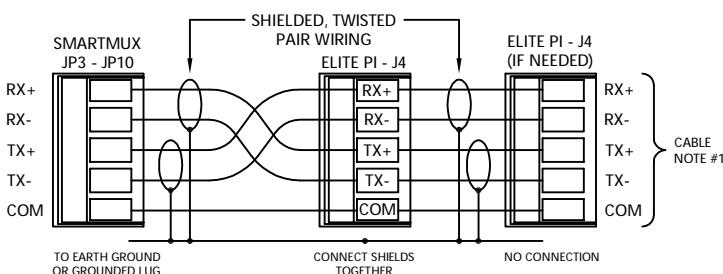

NOTE: Shields **MUST** be grounded to controller/earth ground lug

## S2 DIP SWITCH SETTINGS

ARRIVAL ARROWS & DESTINATIONS DS1 - DS7 set the unit's floor number.

DS7 (64)	DS6 (32)	DS5 (16)	DS4 (8)	DS3 (4)	DS2 (2)	DS1 (1)	FLOOR NUMBER
OFF	OFF	OFF	OFF	OFF	OFF	OFF	CAR UNIT
OFF	OFF	OFF	OFF	OFF	OFF	ON	FLOOR 1
OFF	OFF	OFF	OFF	OFF	ON	OFF	FLOOR 2
OFF	OFF	OFF	OFF	OFF	ON	ON	FLOOR 3
:	:	:	:	:	:	:	:
:	:	:	:	:	:	:	:
ON	ON	ON	ON	ON	OFF	ON	FLOOR 125
ON	ON	ON	ON	ON	ON	OFF	FLOOR 126
ON	ON	ON	ON	ON	ON	ON	NOT USED

Switch 8 sets the unit as front or rear. DS8 OFF - Front Unit DS8 ON - Rear Unit

### VIDEO TEST MODE

Video test mode uses a combination of DIP switch and rotary switch settings. Please write down the initial setting of the S3 and S4 rotary switches before starting this process.

#### Entering Video Test Mode

Set DIP switch 1 to OFF, then set S3 and S4 to position F. Next, set DIP switch 1 to ON. The Live Video Adjustment menu will appear on the screen with Brightness highlighted.

#### Choosing Item to Adjust

The highlighted item is the current selection. To choose a different item to adjust, set S3 as shown below:

S3	Adjustment	S3	Adjustment
F	Brightness	B	Video Standard
E	Contrast	A	Vertical Stretch
D	Color	9	Default
C	Tint	8	Original

### Making Adjustments

Highlight the item to change and turn S4 for the best display quality.

#### Default and Original Settings

Default resets the display to the factory default settings. Original cancels any changes made and restores the values stored before entering Video Test mode. Highlight the item to use, turn S4 in either direction, and wait five seconds. The display will reset to the default or previous settings.

#### Exiting Video Test Mode

To save the new video settings and exit Video Test, set DIP switch 1 to OFF. Reset S3 and S4 to the values recorded before starting the process.

### Video Gain

JP7 and JP6 control the video gain. Use a shunt to short the pins of the jumpers as shown in the table below (OFF = No Shunt, ON = Shunt):

JP7	JP6	VIDEO GAIN
OFF	OFF	No Gain (Default)
OFF	ON	Lowest Gain
ON	OFF	
ON	ON	Highest Gain

### Adjusting Audio Volume

If you need audio, connect an 8-ohm speaker to J2 on the Elite PI board. Set the volume by adjusting Volume pot R2 (3/4 turn pot). Adjust the pot clockwise to increase the volume.

### CABLE NOTES:

- 1) Use shielded, twisted pair wires. We recommend using 24-gauge or larger wires. NOTE: Connect shields to controller/earth ground.
- 2) Use one wire of a twisted pair or a separate wire for common.
- 3) The audio input cable should be a shielded, twisted pair cable.
- 4) BNC composite video cable - 75 ohm RG6 recommended.
- 5) Twisted pair video cable - Unshielded twisted-pair wire recommended. Baluns required - C.E.# V23501P02

DATE DRAWN: 02/10/16	DRAWN BY: DAC	REQUESTED BY: TE	 C.E. ELECTRONICS, INC. 2107 Industrial Drive Bryan, OH 43306 (419) 636-6705
BOARD NUMBER: 3824	LAST DATE REVISED: 10/06/17	APPROVED BY:	
PRODUCT CE3824 TFT Setup Information			DWG. NO. CE3824_SETUP
			REV. B