

EURO DM TWO-CUBE DISPLAYS

JOB# _____

CE3075 DISPLAY BOARD

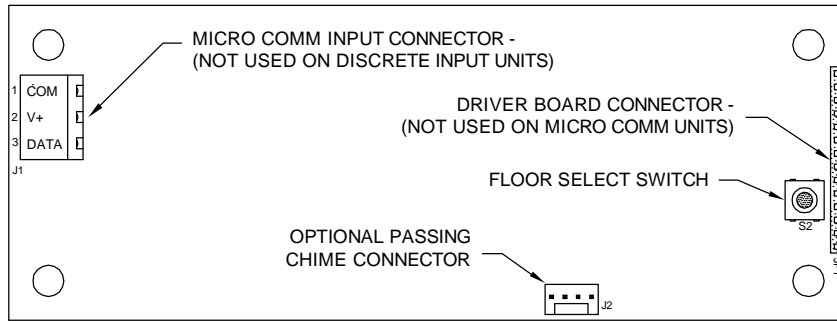

CE3075 BACK VIEW

S2 FLOOR SELECT SWITCH - SETS THE DISPLAY TO SHOW AN ARRIVAL ARROW WHEN THE CAR IS AT A SPECIFIC FLOOR. TO SET THE UNIT FOR ARRIVAL MODE, POSITION THE CAR AT THE DESIRED FLOOR OR TURN ON SELF-TEST. WHEN THE DISPLAY SHOWS THE DESIRED FLOOR, PRESS AND HOLD S2 UNTIL THE FLOOR POSITION CHANGES TO AN ARROW. TO RETURN TO NORMAL OPERATION, PRESS AND HOLD S2 UNTIL THE ARROW CHANGES TO THE FLOOR POSITION.

DIP SWITCH DETAIL



- 1 SELF-TEST
- 2 REDUNDANCY
- 3 FIRE ALT BLANK
- 4 FIRE MAIN BLANK
- 5 UP/DN ROLL RATE
- 6 SIDE SCROLL RATE
- 7
- 8

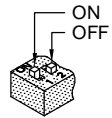

DEFAULT SETTINGS

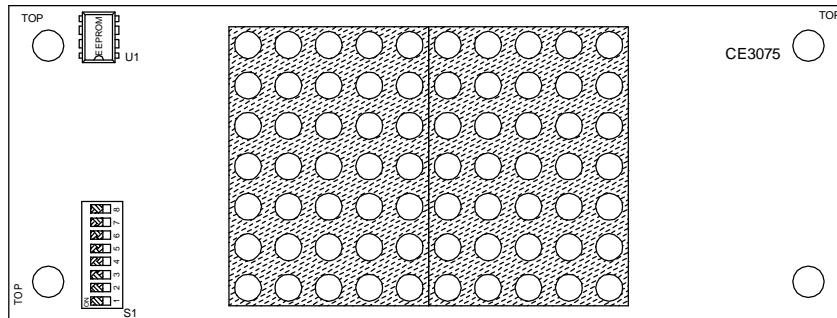
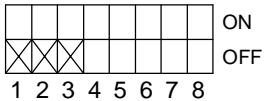

EH220

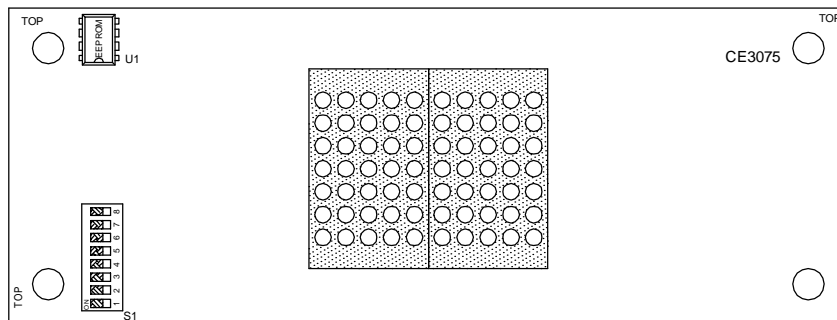

EH210

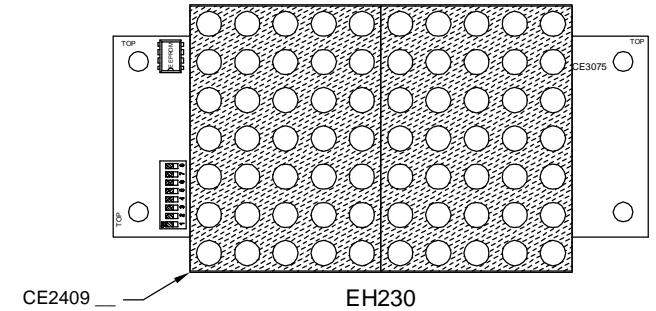

EH230

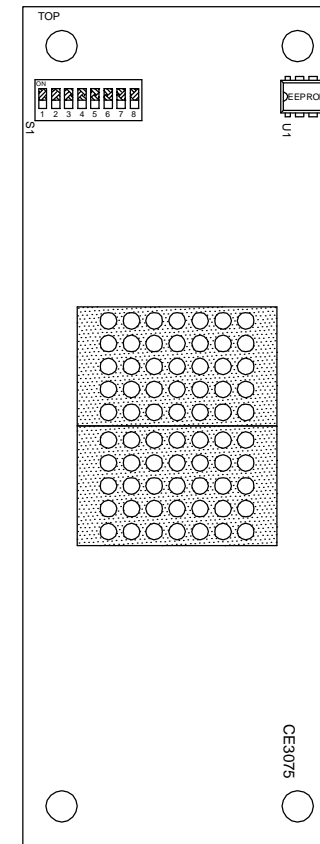

EV115

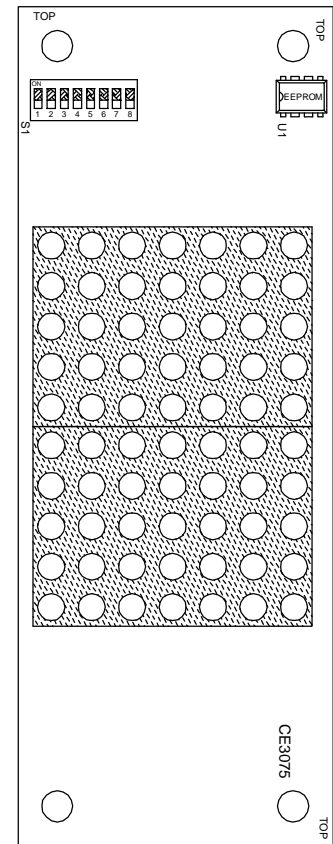

EV130

CODE VERSION _____

BOARD VERSION CE3075 _____

DATE DRAWN: 08/03/05	DRAWN BY: DAC	REQUESTED BY: DV	 C.E. ELECTRONICS, INC. 2107 Industrial Drive Bryan, Ohio 43506 (419) 636-8705
BOARD NUMBER: 3075	LAST DATE REVISED: 10/29/10	APPROVED BY:	
PRODUCT EURO DOT MATRIX TWO-CUBE DISPLAYS			
DWG. NO. EURODM 03			REV. A